

UNCONTROLLED DOCUMENT

PART NUMBER  
SML-LXR85YC-TR

REV.  
K

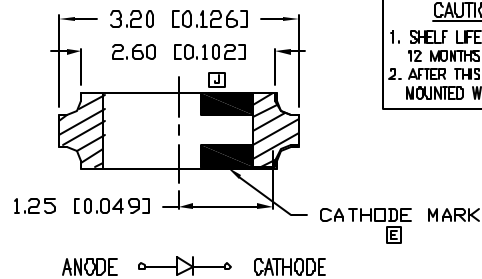

**CAUTION: MOISTURE SENSITIVE DEVICE**  
 1. SHELF LIFE IN SEALED BAG:  
 12 MONTHS AT <40°C AND <80% RELATIVE HUMIDITY (RH).  
 2. AFTER THIS BAG IS OPENED, DEVICES HAVE TO BE  
 MOUNTED WITHIN 48 HOURS OR STORED AT <30% RH.

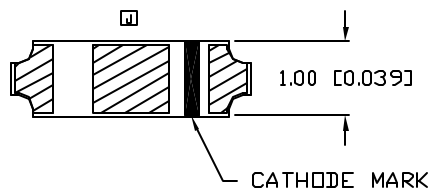
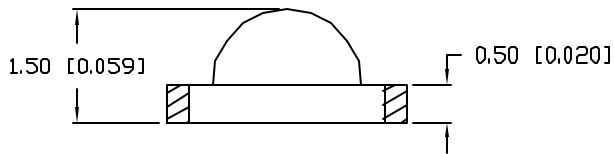
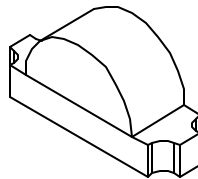

LEAD FREE REFLOW PROFILE

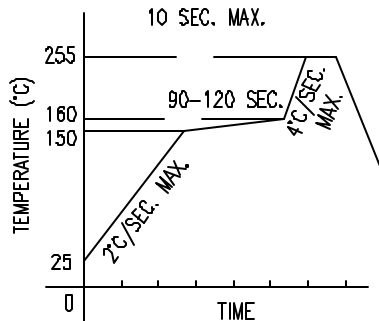

TOTAL TIME ABOVE 220°C IS 60 SECONDS MAX.

RECOMMENDED SOLDER PAD LAYOUT

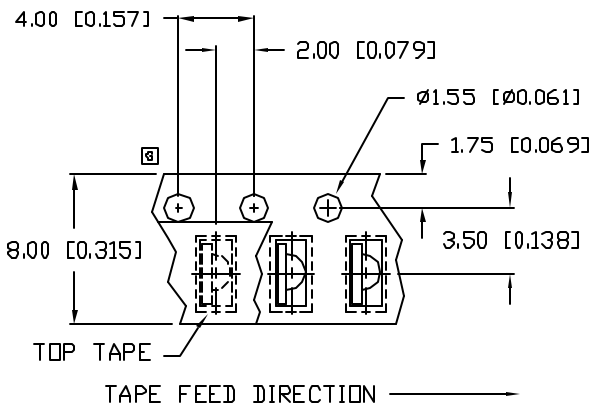
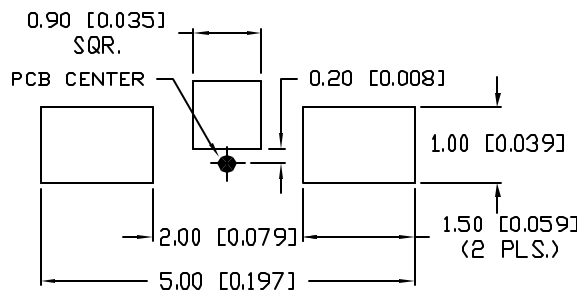

REV.	E.C.N. NUMBER AND REVISION COMMENTS	DATE
A	E.C.N. #10230.	8.23.96
B	E.C.N. #10263.	10.24.96
C	E.C.N. #10338.	5.2.97
D	E.C.N. #10366.	7.22.97
E	E.C.N. #10380.	9.19.97
F	E.C.N. #10BRDR & REDRAWN.	10.15.97
G	E.C.N. #10419.	3.5.98
H	E.C.N. #10471.	10.23.98
I	E.C.N. #10644.	7.18.00
J	E.C.N. #10BRDR. & #10771.	7.30.01
K	E.C.N. #11248.	8.12.05

ELECTRO-OPTICAL CHARACTERISTICS  $T_A=25^\circ\text{C}$   $I_f=20\text{mA}$

PARAMETER	MIN	TYP	MAX	UNITS	TEST COND
PEAK WAVELENGTH		585		nm	
FORWARD VOLTAGE		2.1	2.6	V <sub>f</sub>	
REVERSE VOLTAGE	5.0			V <sub>r</sub>	I <sub>f</sub> =100μA
AXIAL INTENSITY		10		med	I <sub>f</sub> =20mA
VIEWING ANGLE		130		2x theta	
EMITTED COLOR:	YELLOW				
EPOXY LENS FINISH:	WATER CLEAR				

LIMITS OF SAFE OPERATION AT 25°C

PARAMETER	MAX	UNITS
PEAK FORWARD CURRENT*	100	mA
STEADY CURRENT	25	mA
POWER DISSIPATION	65	mW
DERATE FROM 25°C	-1.2	mW/°C
OPERATING TEMP.	-25 TO +85	°C
STORAGE TEMP.	-30 TO +85	°C

\*  $t < 10\mu\text{s}$

NOTES:

- 3,000 PIECES PER REEL.
- THE CATHODE IS ORIENTED TOWARDS THE TAPE SPROCKET HOLE.



UNCONTROLLED DOCUMENT

\*UNLESS OTHERWISE SPECIFIED TOLERANCES PER DECIMAL PRECISION ARE: X=±1 (±0.039), XX=±0.5 (±0.020), XXX=±0.25 (±0.010), XXXX=±0.127 (±0.005), LEAD SIZE=±0.05 (0.002), LEAD LENGTH=±0.75 (±0.030), MIN.= +DECIMAL PRECISION -0.00, MAX.= +0.00 -DECIMAL PRECISION

REV. K	PART NUMBER SML-LXR85YC-TR
-----------	-------------------------------

**CONFIDENTIAL INFORMATION**  
 THE INFORMATION CONTAINED IN THIS DOCUMENT IS THE PROPERTY OF LUMEX INC. EXCEPT AS SPECIFICALLY AUTHORIZED IN WRITING BY LUMEX INC., THE HOLDER OF THIS DOCUMENT SHALL KEEP ALL INFORMATION CONTAINED HEREIN CONFIDENTIAL AND SHALL PROTECT SAME IN WHOLE OR IN PART FROM DISCLOSURE AND DISSEMINATION TO ALL THIRD PARTIES.



290 E. HELEN ROAD  
 PALATINE, IL 60067-6976  
 PHONE: +1.847.359.2790  
 US WEB: www.lumex.com  
 TW WEB: www.lumex.com.tw

0.5mm x 3.2mm PCB, RIGHT ANGLE SURFACE MOUNT LED,  
 585nm YELLOW, WATER CLEAR LENS, 3K PER REEL.

**RELIABILITY NOTE**  
 OUR MANY YEARS OF EXPERIENCE DATA ACCUMULATION INDICATE THAT SOLDER HEAT IS A MAJOR CAUSE OF EARLY AND FUTURE FAILURE. PLEASE PAY ATTENTION TO YOUR SOLDERING PROCESS.

DRAWN BY: ct	CHECKED BY:	APPROVED BY:	DATE: 4.24.96
			PAGE: 1 OF 1
			SCALE: N/A